

Data Sheet



Article number: 04H061501000100

Description: Stabilus IndustryLine gas spring size 06/15
100N length 232mm, stroke 100mm Type 04H0615100

Measures

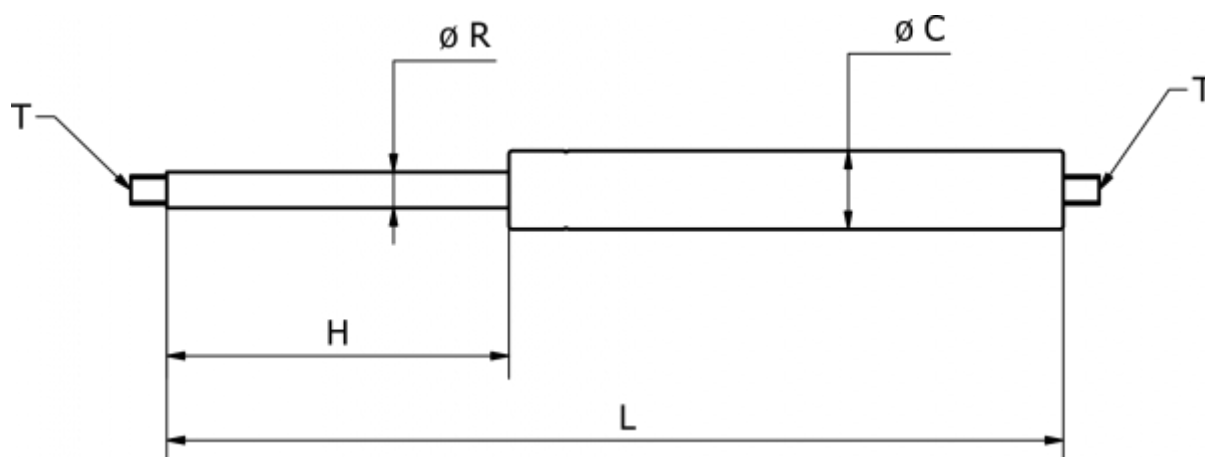

C = 15
H = 100
L = 232
R = 6
T = M5 x 5